

# ASCENT X<sup>2</sup>



16-X2

CELLULAR MULTI-TENANT ENTRY SYSTEM WITH DIRECTORY INSERT

## FEATURES

- Directory panel for user-printed inserts
- 4G LTE cellular
- High-definition Ascent Camera for still photos
- Photo push notifications
- 2 Wiegand inputs
- Ascent Link integration
- Control up to 2 gates/doors
- Cloud-based access control management
- Up to 10,000 app, text, and voice users
- Configurable keypad code length (4 to 6 digits)
- Rollover calling—up to 3 phone numbers per address
- Push and/or email event and status notifications



GET THE SUMMIT CONTROL APP



powered by  **SUMMIT CONTROL**

## CALLING MADE EASY

Key in the directory code listed next to the resident you wish to call and the unit calls.

## AN ASCENT WITH A VIEW

Get visual ID for all guests with photo push notifications, and receive photos automatically or whenever you choose.

## A DIRECTORY THAT'S UP TO DATE

As residents come and go, use our ready-made templates to print new inserts.

## GET CONNECTED EVERY TIME

Assign up to three phone numbers to each address to be called one after the other, ensuring a connection is always made.



## SPECIFICATIONS

### PHYSICAL

Dimensions	13.05"(H) x 6.50"(W) x 5.15"(D)
Shipping Weight	10 lbs.

### ELECTRICAL

Input	12–24 VAC/DC 12-VDC power supply included (PS-12DC1)
Current Draw	less than 190 mA @ 12 VDC less than 160 mA @ 24 VDC with relay latched, LEDs and backlit keypad on

### RELAY

Contact Rating	10 A @ 120 VAC / 24 VDC
Max Switching Voltage	250 VAC / 30 VDC
Max Switching Current	15 A
Max Switching Power	240 W / 2,770 VA

### COMMUNICATION







Cellular Network	4G LTE
------------------	--------

### ENVIRONMENTAL

Operating Temperature	-15 to 158 °F
-----------------------	---------------

▲ Actual voltage should be no more than 10% beyond specified range. Use of the included 12-VDC power supply is recommended.

## CONTROL IT YOUR WAY

-  APP
-  TEXT
-  VOICE
-  KEYPAD\*
-  DIRECTORY CALL
-  WIEGAND DEVICES

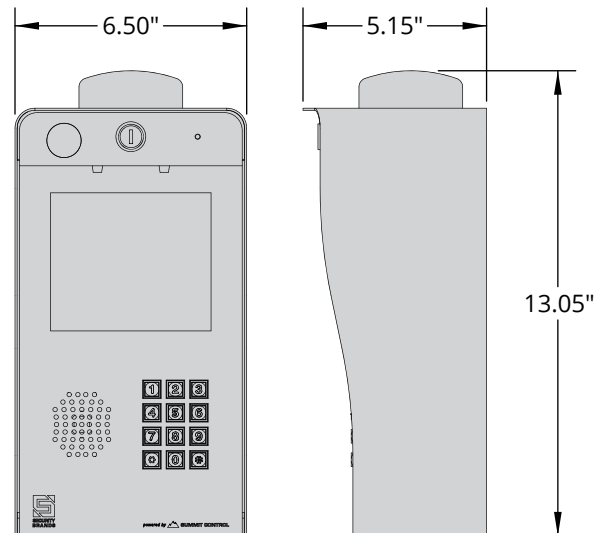

## GET STARTED NOW!

### PAY JUST **ONE BILL!**\*

Unit includes a GSM SIM card ready for activation.

**We do ALL the legwork for you!**



**SUMMIT CONTROL**



\* Because keypad codes are managed via Summit Control, they cannot be added or deleted without an active service plan.  
† Monthly bill covers cost of SIM card, actions gateway, servers, maintenance, development, app, and tech support.