

# ASCENT M<sup>4</sup>



16-M4 CELLULAR MULTI-TENANT ENTRY SYSTEM WITH 4-LINE LCD

## FEATURES

- Large 20x4 LED-backlit LCD directory
- 4G LTE cellular
- High-definition Ascent Camera for still photos
- Photo push notifications
- 2 Wiegand inputs
- Ascent Link integration
- Control up to 2 gates/doors
- Cloud-based access control management
- Up to 10,000 app, text, and voice users
- Configurable keypad code length (4 to 6 digits)
- Rollover calling—up to 3 phone numbers per address
- Push and/or email event and status notifications



powered by  **SUMMIT CONTROL**

GET THE SUMMIT CONTROL APP



## SIMPLY EASY

The LCD directory is simple to understand and easy to read, even in bright sunlight.

## NO-NONSENSE INTERFACE

Navigating the on-screen resident directory couldn't be any easier for guests. Simply find your party and press the button to call.

## POWERFULLY EXPANDABLE

Network multiple Ascent units together and manage multiple entries via Summit Control.

## GET CONNECTED EVERY TIME

Assign up to three phone numbers to each address to be called one after the other, ensuring a connection is always made.



## SPECIFICATIONS

### PHYSICAL

Dimensions 16.55"(H) x 10.50"(W) x 4.74"(D)  
 Shipping Weight 18 lbs.

### ELECTRICAL

Input 12–24 VAC/DC  
 12-VDC power supply included (PS-12DC2)  
 Current Draw dependent on user settings  
 Unit requires constant power source and is not recommended for solar applications

### RELAY

Contact Rating 10 A @ 120 VAC / 24 VDC  
 Max Switching Voltage 250 VAC / 30 VDC  
 Max Switching Current 15 A  
 Max Switching Power 240 W / 2,770 VA

### COMMUNICATION

Cellular Network 4G LTE







### ENVIRONMENTAL

Operating Temperature -15 to 158 °F

▲ Actual voltage should be no more than 10% beyond specified range. Use of the included 12-VDC power supply is recommended.

## CONTROL IT YOUR WAY

2<sup>DOOR</sup>

-  APP
-  TEXT
-  VOICE
-  KEYPAD\*
-  DIRECTORY CALL
-  WIEGAND DEVICES

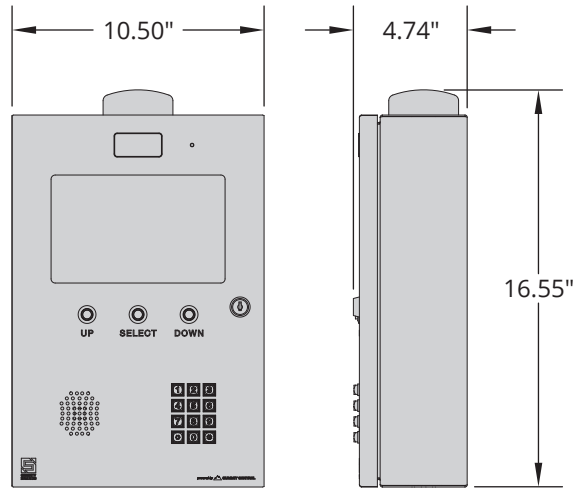

## GET STARTED NOW!

### PAY JUST **ONE BILL!**\*

Unit includes a GSM SIM card ready for activation.

**We do ALL the legwork for you!**



**SUMMIT CONTROL**



\* Because keypad codes are managed via Summit Control, they cannot be added or deleted without an active service plan.  
 † Monthly bill covers cost of SIM card, actions gateway, servers, maintenance, development, app, and tech support.