

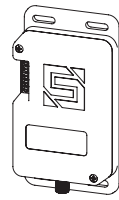

IN THE BOX

Make sure you have everything shown here.



Receiver 300

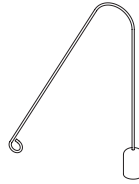

Antenna

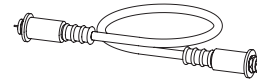

1.5-foot Coaxial Cable



Coaxial Connector

WHAT'S WHAT

1. DIP switches
2. RF status LED
3. Power and relay terminals
4. Coaxial antenna connector

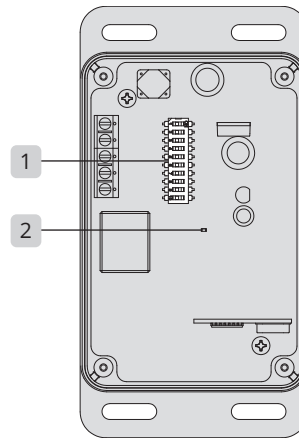

Receiver 300
(cover removed)

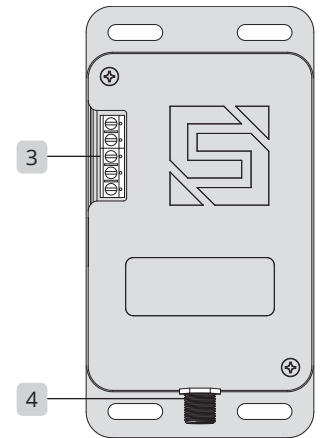

Receiver 300
(cover in place)

SETUP

1. Remove screws from Receiver 300 unit cover and remove cover to reveal DIP switches.

CAUTION! Be gentle with coaxial connection when removing cover. Do not let cover hang free; doing so may damage unit!

2. Set DIP switches to desired positions.

NOTE: For best results, we recommend using the Security Brands Remote 300 (14-R300).

NOTE: By default, the DIP switches are matched to the default DIP switch positions on the Remote 300 and other 300-MHz remotes. For security reasons, we recommend using custom DIP switch positions.

NOTE: Some DIP switches may be labeled differently. The position labeled 10 corresponds to the position labeled 0, and some DIP switches have the off position labeled as OPEN.

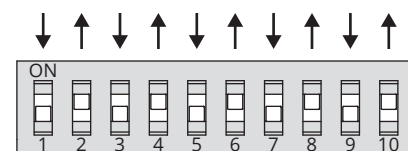
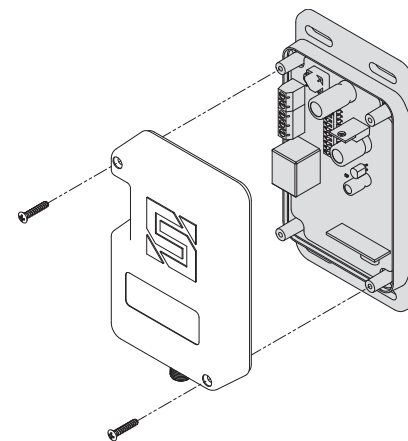

DIP Switches on Receiver 300
(default positions)

WIRING AND INSTALLATION

1. Connect power and relay wires to screw terminals on Receiver 300 unit, and connect other ends to gate or door operator as instructed by gate or door operator manual. Tighten screws to secure. If using an AC/DC adapter, plug in at this time.

CAUTION! Do not exceed 12-24 VAC/DC input! Doing so may damage receiver unit!

2. Mount Receiver 300 unit inside gate or door operator near control circuit board using Tek screws, zip ties, or other means of securing.

CAUTION! The receiver is not weatherproof. Mount inside a weatherproof enclosure to protect internal components from damage!

3. Securely connect included antenna to coaxial connector on bottom end of Receiver 300 unit. Slide rubber sleeve over connector to protect.

i If mounting the Receiver 300 unit inside a metal enclosure, such as a gate operator housing, you will need the **Security Brands Antenna 300 (14-ANT300)**, which comes with a 15-foot coaxial cable, antenna, coaxial connector, mounting bracket, and hardware for mounting outside the metal enclosure.

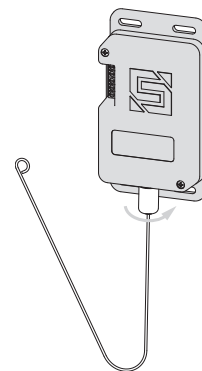
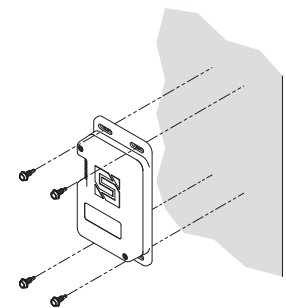
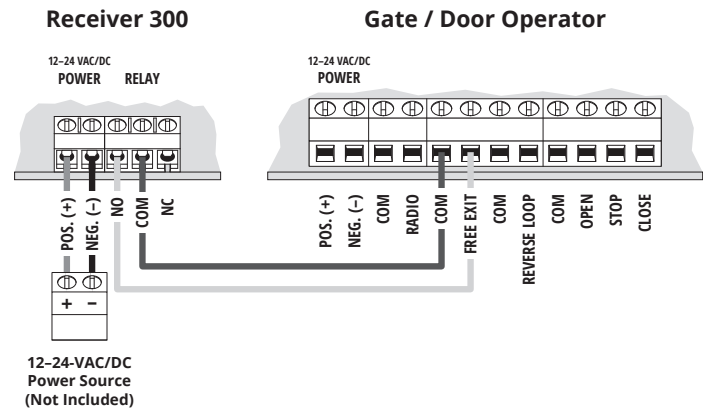

HOW TO USE

1. Make sure you are in range of Receiver 300 unit.
2. Press button on remote linked to receiver.
3. Receiver will respond and operate gate/door.

NOTE: If the receiver does not respond, make sure it has power and that the antenna is not inside a metal box or otherwise blocked. If the receiver still does not respond, make sure the DIP switch positions on both the receiver and the remote(s) match.

WARNING! AUTOMATIC GATES CAN CAUSE SERIOUS INJURY OR DEATH! ALWAYS CHECK THAT THE GATE PATH IS CLEAR BEFORE OPERATING! REVERSING OR OTHER SAFETY DEVICES SHOULD ALWAYS BE USED!

Two-Year Limited Warranty

Visit securitybrandsinc.com/warranty/ for details



SECURITY BRANDS INC™

your *partner* in access control